

Produced by *On The Right Wavelength* for Samson Technologies Corp.

Copyright 1996, 1997, Samson Technologies Corp.

Printed February, 1997

Samson Technologies Corp.
575 Underhill Blvd.
P.O. Box 9031
Syosset, NY 11791-9031
Phone: 1-800-3-SAMSON (1-800-372-6766)
Fax: 516-364-3888

Table of Contents

Introduction 1

MIXPAD Features 2

Guided Tours 4

MIXPAD 12/9 Channels 4

MIXPAD 12/9 Main Section 8

MIXPAD 12/9 Jackfield 10

Connecting the MIXPAD 4 Carrying Strap 11

MIXPAD 4 Channels 12

MIXPAD 4 Main Section 16

MIXPAD 4 Jackfield 18

Connecting the MIXPAD 19

Setting Up and Using the MIXPAD 22

Setting the Correct Gain Structure 23

Grounding Techniques 26

Using Pan/Balance 28

Using Equalization 30

Using Aux Sends and Returns 32

Appendix A: Operating the MIXPAD 12/9 off Battery Power 34

MIXPAD 12/9 Specifications 36

MIXPAD 4 Specifications 37

Introduction

Congratulations on your purchase of the Samson MIXPAD! One of the smallest mixers ever made, the MIXPAD provides excellent sound quality and a wealth of features normally found only in full-size units. Although it has been designed for easy operation, we suggest you take some time to go through these pages so you can fully understand how we've implemented a number of unique functions.

This manual covers three models: the MIXPAD 12, MIXPAD 9, and MIXPAD 4. The first two of these are identical apart from the fact that the MIXPAD 12 provides six monophonic and three stereo input channels (for a total of twelve channels), while the MIXPAD 9 provides three monophonic and three stereo input channels (for a total of nine channels). The MIXPAD 4 provides two monophonic input channels and one stereo input channel (for a total of four channels) and offers a slightly different feature set (such as three-band equalization and independent channel phantom power switches). Because of their unusually small size and portability, all three models are well-suited for specialized applications such as videography, remote site recording, ENG (Electronic News Gathering), or audio coverage of fast-paced outdoor events such as sports shows.

In these pages, we'll provide you with an overview of the unit's features, followed by a guided tour of the MIXPAD channels, main section and jackfield. Then we'll describe how to set up your MIXPAD, including instructions on how to set the optimum gain structure. Next, we'll cover a number of specific MIXPAD functions (such as panning, equalization, and auxiliary sends and returns) in detail. Finally, we'll wrap things up with full specifications. You'll also find a warranty card enclosed—please don't forget to fill it out and mail it so that you can receive online technical support and so we can send you updated information about these and other Samson products in the future.

SPECIAL NOTE: Should your MIXPAD ever require servicing, a *Return Authorization* (RA) number is necessary. Without this number, the unit will not be accepted. Please call Samson at 1-800-372-6766 for a Return Authorization number prior to shipping your unit. Please retain the original packing materials and, if possible, return the unit in its original carton and packing materials.

MIXPAD Features

The compact design of the MIXPAD belies an extraordinary versatility. Add excellent sound quality to the equation, and you've got a product which is equally useful as a live performance mixer and for field recording applications. Here are some of the MIXPAD's main features:

- In the MIXPAD 12, a total of twelve input channels (including three stereo channels); in the MIXPAD 9, a total of nine input channels (including three stereo channels); in the MIXPAD 4, a total of four input channels (including one stereo channel). Monophonic channels provide electronically balanced inputs that can be used for microphone or line-level input, while stereo channels are ideal for line-level sources such as outboard signal processors; CD players; tape or cassette recorders; stereo drum machines; and keyboards and MIDI tone modules.
- An electronically balanced main stereo output for connection to a power amplifier or tape recorder.
- A dedicated Tape/CD input for playback of prerecorded material.
- In the MIXPAD 12 and MIXPAD 9, two auxiliary sends and two stereo auxiliary returns (which can be used as four monophonic returns). Aux send 1 is pre-fader (but post-equalizer), making it ideal for use as a headphone or monitor cue mix, while Aux send 2 is post-fader and post-equalizer.
- In the MIXPAD 4, one auxiliary send and one stereo auxiliary return (which can be used as two monophonic returns), with the aux send post-fader and post-equalizer.
- In the MIXPAD 12 and MIXPAD 9, independent 2-band equalization for each channel, with 15 dB of cut or boost for low (100 Hz) and high (10 kHz) frequencies.
- In the MIXPAD 4, independent 3-band equalization for each channel, with 15 dB of cut or boost for low (80 Hz) and high (12 kHz) frequencies, and 12 dB of cut or boost for the mid (2.5 kHz) frequency.

MIXPAD Features

- Constant level pan controls for placing each monophonic channel in the left-right stereo spectrum, as well as balance controls that allow you to blend the relative levels of stereo inputs.
- Mic input trims that are continuously adjustable from +4 to -50 dB, making it possible to use the MIXPAD with a wide variety of microphones.
- The MIXPAD 12 and MIXPAD 9 provide 36 volts of phantom power to all mic inputs, while the MIXPAD 4 provides 18 volts of phantom power (with independent switches for each of its two mic input channels), making it possible to use most condenser and dynamic mics, as well as active DI (Direct Injection) boxes.
- Peak LEDs for the left and right main outputs, showing you when signal is overloading or near overloading.
- Center detents for all pan, balance, and EQ controls, making it easy to access them in low-light situations such as live performance.
- Convenient front-panel Power switch, Power LED and dedicated headphone jack.
- The MIXPAD 4 runs on either AC or battery power (requiring just two standard 9 volt batteries—three if you need phantom power), with optional battery power available for the MIXPAD 12 and MIXPAD 9 (see Appendix A on page 34), enabling the unit to be used for ENG (Electronic News Gathering), field broadcast and recording purposes. In the MIXPAD 4, the front-panel Power LED also indicates battery strength.
- The MIXPAD 4 includes a handy carrying strap for easy portability.
- Last but certainly not least, affordability. The Samson MIXPAD has been designed from the ground up to provide versatility and excellent sound quality at a cost-conscious price.

Guided Tour - MIXPAD 12 /MIXPAD 9 Channels

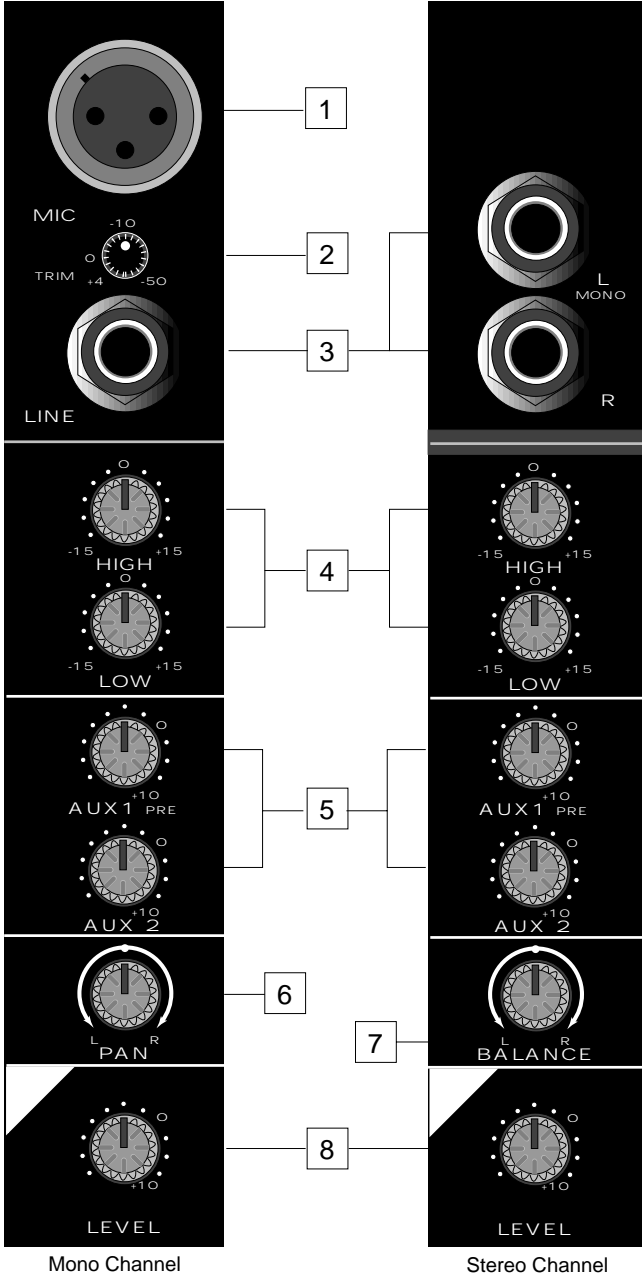

Guided Tour - MIXPAD 12 / MIXPAD 9 Channels

1: Mic inputs - Provided in monophonic channels only (channels 1 - 6 in the MIXPAD 12 and channels 1 - 3 in the MIXPAD 9). Use these electronically balanced XLR jacks to connect microphones to any of the MIXPAD's monophonic channels. These are intended to accept signal from low-level, low-impedance mics but can also be used for signal from other sources (such as direct injection boxes) if the channel's Trim control is turned down (see #2 below). All MIXPAD 12 and MIXPAD 9 XLR mic connectors are 36 volt phantom powered, enabling you to connect a wide variety of condenser or dynamic microphones.

WARNING: Do not connect a channel's microphone input if you already have something connected to its line input; each channel is designed to accept only one source or the other.

2: Trim - Provided in monophonic channels only (channels 1 - 6 in the MIXPAD 12 and channels 1 - 3 in the MIXPAD 9). This knob determines the input level of the connected mic or line signal. Continuously adjustable from +4 dB to -50 dB, the input trim is at unity gain (no boost or cut) when set to the "0" (9 o'clock) position. The input signal is boosted when the trim is turned to the right of "0" and attenuated when turned to the left of "0." For information on how to properly set this for each channel, see the section on page 23 entitled "Setting The Correct Gain Structure."

3: Line inputs - Use these standard 1/4" jacks to connect line-level sources such as synthesizers, drum machines, CD players, tape decks, or effects processors to any of the MIXPAD's mono or stereo channels. The line input jacks for monophonic channels (channels 1 - 6 in the MIXPAD 12 and channels 1 - 3 in the MIXPAD 9) are electronically balanced, so you should use balanced three-conductor cabling and Tip/Ring/Sleeve (TRS) plugs wherever possible (unbalanced two-conductor plugs can also be inserted into these inputs, but you'll get better signal quality and less outside noise and hum if you use balanced lines). **WARNING:** Do not connect a channel's line input if you already have something connected to its microphone input; each channel is designed to accept only one source or the other.

The line input jacks for stereo channels (channels 7 - 12 in the MIXPAD 12 and channels 4 - 9 in the MIXPAD 9) are unbalanced. When connecting only one monophonic signal to stereo channels, use the left (even-numbered) input; the MIXPAD will then treat that channel as if it is a mono channel, allowing the signal to be panned (using the

Guided Tour -

MIXPAD 12 / MIXPAD 9 Channels

Balance control)—see the “Using Pan/Balance” section on page 28 for more information. See the “Connecting The MIXPAD” section on page 19 for additional information on how best to use channel inputs.

4: Equalizer (violet) - These knobs determine the amount of boost or attenuation in each of two frequency areas. The high and low frequency knobs provide 15 dB of cut or boost at 10 kHz and 100 Hz, respectively. Both frequency controls utilize a shelving curve. In stereo channels, EQ settings affect both the left and right inputs, although the signals remain separate. A center detent in each knob (at the “0” position) indicates no boost or attenuation (that is, flat response). As each knob is turned clockwise from the “0” position, the frequency area is boosted; as it is turned counterclockwise from the “0” position, the frequency area is attenuated. For more information on the application of EQ, see the “Using Equalization” section on page 30.

5: Auxiliary sends (blue) - These knobs allow you to route signal to either or both of the MIXPAD’s two monophonic Auxiliary outputs. These are typically used to create submixes (for example, a headphone cue mix) and to feed signal from single or multiple channels to outboard effects devices. At the “0” (2 o’clock) position, the signal is routed with unity gain (that is, no boost or attenuation). As each knob is turned clockwise from the “0” position, the signal is boosted; as it is turned counterclockwise from the “0” position, it is attenuated. Aux send 1 is post-eq but *pre-fade*; that is, the level of the signal is determined solely by its EQ settings and by its Trim control; see #2 on the previous page. Aux send 2 is post-eq and *post-fade*; that is, the level of the signal is determined by the channel’s Trim control, its EQ settings, and the position of its Level control. See the “Using Aux Sends and Returns” section on page 32 for more information.

6: Pan (green) - Provided in monophonic channels only. This knob allows you to place the input signal anywhere in the left-right stereo spectrum, while keeping the overall signal level constant. When the knob is placed at its center (detented) position, the signal is sent equally to both left and right outputs. When moved left of center, less signal is sent to the right output and more signal is sent to the left output (making the sound appear left of center) and when moved right of center, less signal is sent to the left output and more signal is sent to the right output (making the sound appear right of center). To route a signal hard left or right, place the pan knob either fully counterclockwise or fully clockwise.

Guided Tour - MIXPAD 12 / MIXPAD 9 Channels

7: Balance (brown) - Provided in stereo channels only. When both inputs are connected to a stereo channel, the upper input signal (channels 7, 9, and 11 in the MIXPAD 12 and channels 4, 6, and 8 in the MIXPAD 9) is automatically panned hard left and the lower input signal (channels 8, 10, and 12 in the MIXPAD 12 and channels 5, 7, and 9 in the MIXPAD 9) is automatically panned hard right. In this case, the “Balance” knob controls the relative levels of the paired input signals. When the knob is placed at its center (detented) position, both signals are at equal strength. When moved left of center, the upper input remains at the same strength but the lower input is attenuated; when the knob is moved right of center, the lower input remains at the same strength but the upper input is attenuated. When placed fully counter-clockwise, only the upper input is heard (panned hard left); when placed fully clockwise, only the lower input is heard (panned hard right). In stereo channels where only the upper input is connected, the Balance knob works like a mono channel Pan control; see #6 on the previous page for details. For more information, see the “Using Pan/Balance” section on page 28 in this manual.

8: Level (white) - In mono channels (or in stereo channels where only the upper input is connected), this knob determines the signal level being sent to the main output as well as affecting the signal level being sent to Aux send 2. In stereo channels, this knob simultaneously controls the level of both the upper and lower inputs (the *relative* levels of the two can be adjusted with the Balance knob, as described above) as well as the signal level being sent to Aux send 2. In practice, you will use the channel Level controls to continuously adjust the levels of the various signals being blended together by the MIXPAD. The “0” position of the knob indicates unity gain (no level attenuation or boost). Moving the knob counterclockwise from the “0” position causes the signal to be attenuated (at the very bottom, it is attenuated infinitely—in other words, there is no sound); moving it clockwise from the “0” position causes the signal to be boosted by as much as 10 dB.

For best signal-to-noise ratio, all Level controls for channels carrying signal should generally be kept at or near the “0” position. Channels that are unused should have their gain controls kept fully counterclockwise at their (minimum) level. See the “Setting the Correct Gain Structure” section on page 23 in this manual for more information.

Guided Tour - MIXPAD 12 / MIXPAD 9 Main Section

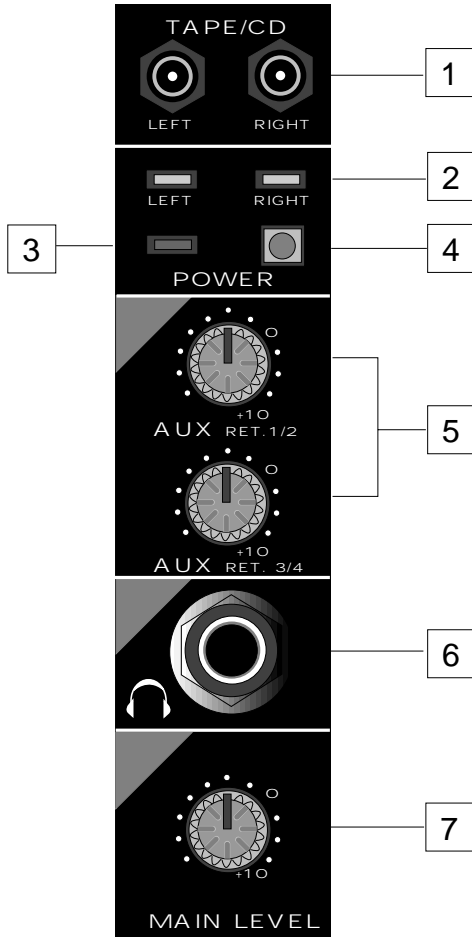

1: Tape/CD inputs (L, R) - Use this set of dual RCA jacks to connect the outputs of a tape or CD player to the MIXPAD. In the MIXPAD 12, signal connected here appears at stereo channel 11/12 and is mixed at unity gain with any line input signal connected to channel 11/12. In the MIXPAD 9, signal connected here appears at stereo channel 8/9 and is mixed at unity gain with any line input signal connected to channel 8/9.

Guided Tour - MIXPAD 12 / MIXPAD 9 Main Section

2: Left/Right Peak LEDs (red) - These warning lights indicate an overload situation. They light whenever the main left or right output signal is 5 dB short of clipping. To stop them from lighting (and to eliminate the accompanying sonic distortion), turn down the Main Level control (see #7 below). See the “Setting the Correct Gain Structure” section on page 23 in this manual for more information.

3: Power LED - This LED lights steadily red whenever the MIXPAD is powered on.

4: Power on-off switch - As you may have guessed, this is what you use to turn the MIXPAD on and off. To avoid potential damage to your speakers, turn the unit on *before* you turn on any connected power amps—and turn it off *after* the power amps are turned off.

5: Stereo Auxiliary Return Level (tan) - These knobs determine the input level of signal arriving via the MIXPAD’s two stereo Auxiliary returns (1/2 and 3/4). Each return is at unity gain (no boost or attenuation) when set to the “0” (2 o’clock) position. The input signal is boosted when the knob is turned to the right of “0” and attenuated when turned to the left of “0.” For information on how to properly set these, see the sections in this manual entitled “Setting the Correct Gain Structure” and “Using the Aux Sends and Returns” (pages 23 and 32). Auxiliary return signal is automatically routed to the Main L/R output.

6: Headphone jack - Connect any standard stereo headphones to this jack (via a standard 1/4" TRS plug) for private monitoring of the main stereo output. The built-in MIXPAD headphone preamp delivers 100 mw at 600 ohms.

7: Main Level (white) - This knob determines the final output signal level—you can think of this as being the “master fader.” Signals from all channels and Auxiliary returns, as well as the Tape/CD input are routed here just before leaving the MIXPAD via its left and right main output jacks. The “0” position of the knob indicates unity gain (no level attenuation or boost). Moving the knob counterclockwise from the “0” position causes the signal to be attenuated (at the very bottom, it is attenuated infinitely—in other words, there is no sound). Moving it clockwise from the “0” position causes the signal to be boosted by as much as 10 dB. For more information, see the “Setting The Correct Gain Structure” section on page 23 in this manual.

Guided Tour - MIXPAD 12 / MIXPAD 9 Jackfield

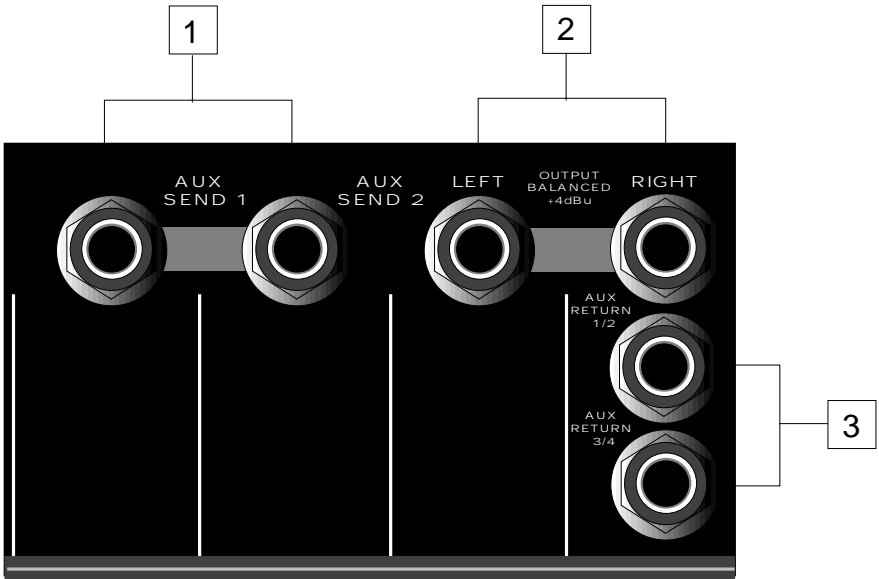

1: Aux Sends (1, 2) - These unbalanced 1/4" outputs allow you to route signal from each of the two discrete Aux Sends to external devices such as effects processors. Aux send 1 is pre-fade but post-EQ, while Aux send 2 is both post-fade and post-EQ. See the "Using the Aux Sends and Returns" section on page 32 in this manual for more information.

2: Main out (L, R) - These are the MIXPAD's main outputs. You'll usually use these to connect the MIXPAD to a tape recorder or to a power amp and loudspeakers. The Main out jacks are electronically balanced, so you should use balanced three-conductor cabling and TRS plugs wherever possible (unbalanced two-conductor plugs can also be inserted into these outputs, but you'll get better signal quality and less outside noise and hum if you use balanced lines). See the "Connecting the MIXPAD" section on page 19 in this manual for more information.

3: Aux Returns (1/2, 3/4) - These inputs allow you to route signal from external devices such as effects processors to either of the MIXPAD's two stereo Aux Returns. These jacks accept unbalanced 1/4" TRS plugs, with the tip carrying the left signal and the ring carrying the right signal (sleeve is common ground). See the "Using the Aux Sends and Returns" section on page 32 in this manual for more information.

Connecting the MIXPAD 4 Carrying Strap

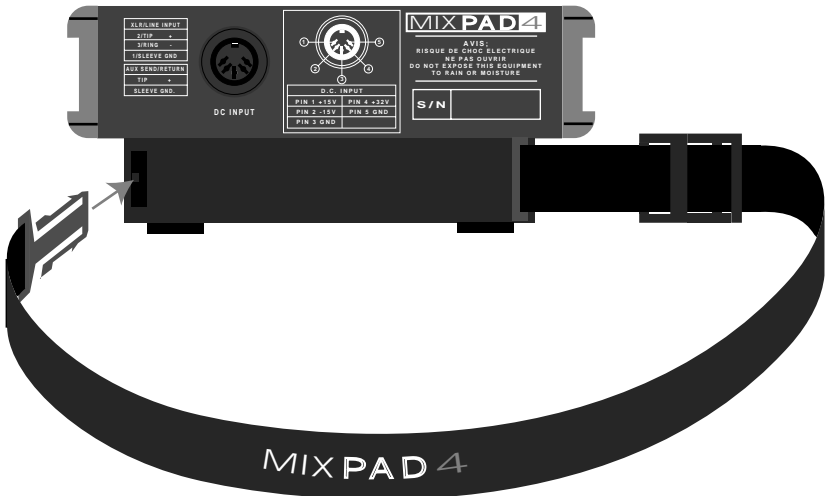

The MIXPAD 4 is supplied with a handy carrying strap for easy portability. As shown in the illustration above, attach the strap to the MIXPAD 4 by placing the buckles in the connector slots and pressing them in firmly until they snap in place. Remove the carrying strap by gently squeezing together the outside buckle clips in order to extract them from the connector slots.

Guided Tour - MIXPAD 4 Channels

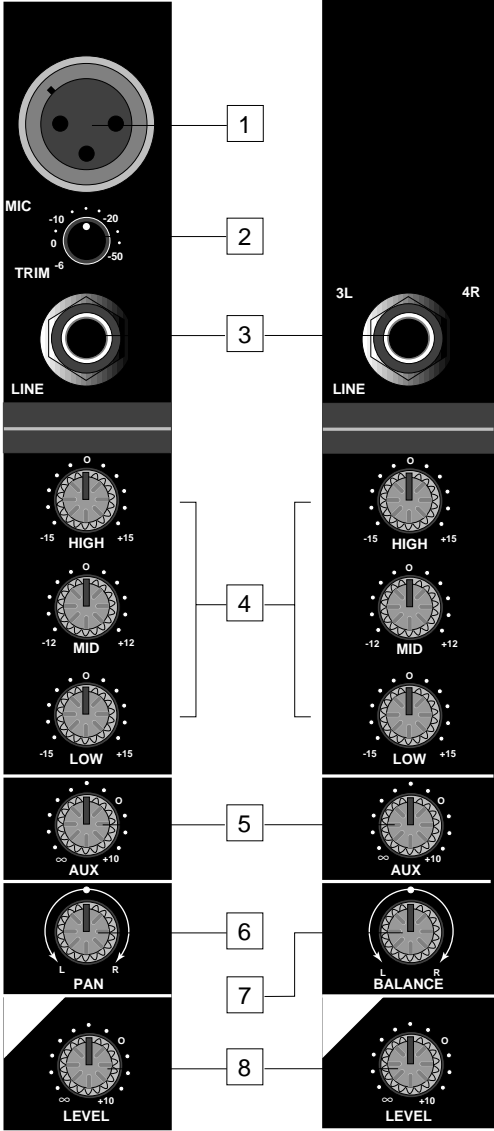

Guided Tour - MIXPAD 4 Channels

1: Mic inputs - Provided in monophonic channels only (channels 1 and 2). Use these electronically balanced XLR jacks to connect microphones to either of the MIXPAD 4's two monophonic channels. These are intended to accept signal from low-level, low-impedance mics but can also be used for signal from other sources (such as direct injection boxes) if the channel's Trim control is turned down (see #2 below). When the channel's Phantom Power switch is pressed in (see #2 on page 16), 18 volts of phantom power is delivered to pins 2 and 3 of that channel's XLR mic input, enabling you to connect most condenser microphones. **WARNING:** Do not connect a channel's microphone input if you already have something connected to its line input; each channel is designed to accept only one source or the other.

2: Trim - Provided in monophonic channels only (channels 1 and 2). This knob determines the input level of the connected mic or line signal. Continuously adjustable from -6 dB to -50 dB, the input trim is at unity gain (no boost or cut) when set to the "0" (9 o'clock) position. The input signal is boosted when the trim is turned to the right of "0" and attenuated when turned to the left of "0." For information on how to properly set this for each channel, see the section on page 23 in this manual entitled "Setting The Correct Gain Structure."

3: Line inputs - Use these 1/4" jacks to connect line-level sources such as synthesizers, drum machines, CD players, tape decks, or effects processors to any of the MIXPAD's mono or stereo channels. The line input jacks for monophonic channels (channels 1 - 2) are electronically balanced, so you should use balanced three-conductor cabling and Tip/Ring/Sleeve (TRS) plugs wherever possible (unbalanced two-conductor plugs can also be inserted into these inputs, but you'll get better signal quality and less outside noise and hum if you use balanced lines). **WARNING:** Do not connect a channel's line input if you already have something connected to its microphone input; each channel is designed to accept only one source or the other.

The line input jack for the stereo channel (channels 3 - 4) accepts a single unbalanced 1/4" TRS plug, with the tip carrying the left signal and the ring carrying the right signal (sleeve is common ground). See the "Connecting The MIXPAD" section on page 19 in this manual for additional information on how best to use channel inputs.

Guided Tour -

MIXPAD 4 Channels

4: Equalizer (violet) - These knobs determine the amount of boost or attenuation in each of three frequency areas. Each knob provides 15 dB of cut or boost at 12 kHz (High) and 80 Hz (Low) frequencies, and 12 dB of cut or boost at the Mid (2.5 kHz) frequency. The High and Low frequencies utilize shelving curves and the Mid frequency utilizes a bell (peaking) curve. In the stereo channel (channels 3 - 4), the EQ settings affect both inputs, although the signals remain separate. A center detent in each knob (at the “0” position) indicates no boost or attenuation (that is, flat response). As each knob is turned clockwise from the “0” position, the frequency area is boosted; as it is turned counterclockwise from the “0” position, the frequency area is attenuated. For more information on the application of EQ, see the “Using Equalization” section on page 30 in this manual.

5: Auxiliary send (blue) - This knob allows you to route signal from any or all channels to the MIXPAD 4’s monophonic Auxiliary output. This is typically used to create a submix (for example, a headphone cue mix) or to feed signal from single or multiple channels to outboard effects devices. At the “0” (2 o’clock) position, the signal is routed with unity gain (that is, no boost or attenuation). As each knob is turned clockwise from the “0” position, the signal is boosted; as it is turned counterclockwise from the “0” position, it is attenuated. The MIXPAD 4 Aux send is post-eq and *post-fade*; that is, the level of the signal is determined by the channel’s EQ settings and the position of its Level control (plus, in mono channels, the position of its Trim control). See the “Using Aux Sends and Returns” section on page 32 for more information.

6: Pan (green) - Provided in monophonic channels (channels 1 - 2) only. This knob allows you to place the input signal anywhere in the left-right stereo spectrum, while keeping the overall signal level constant. When the knob is placed at its center (detented) position, the signal is sent equally to both left and right outputs. When moved left of center, less signal is sent to the right output and more signal is sent to the left output (making the sound appear left of center) and when moved right of center, less signal is sent to the left output and more signal is sent to the right output (making the sound appear right of center). To route a signal hard left or right, place the pan knob either fully counterclockwise or fully clockwise.

Guided Tour - MIXPAD 4 Channels

7: Balance (brown) - Provided in the stereo channel (channels 3 - 4) only. When both inputs are connected to the stereo channel, the channel 3 input signal is automatically panned hard left and the channel 4 input signal is automatically panned hard right. In this case, the “Balance” knob controls the relative levels of the paired input signals. When the knob is placed at its center (detented) position, both signals are at equal strength. When moved left of center, the channel 3 input remains at the same strength but the channel 4 input is attenuated; when the knob is moved right of center, the channel 4 input remains at the same strength but the channel 3 input is attenuated. When placed fully counter-clockwise, only the channel 3 input is heard (panned hard left); when placed fully clockwise, only the channel 4 input is heard (panned hard right). For more information, see the “Using Pan/Balance” section on page 28 in this manual.

8: Level (white) - This knob determines the signal level being sent to the main output. When both channels are connected in the stereo channel , this knob simultaneously controls the level of both inputs (the *relative* levels of the two can be adjusted with the Balance knob, as described above). In practice, you will use the channel Level controls to continuously adjust the levels of the various signals being blended together by the MIXPAD 4. The “0” position of the knob indicates unity gain (no level attenuation or boost). Moving the knob counterclockwise from the “0” position causes the signal to be attenuated (at the very bottom, it is attenuated infinitely—in other words, there is no sound); moving it clockwise from the “0” position causes the signal to be boosted by as much as 10 dB.

For best signal-to-noise ratio, all Level controls for channels carrying signal should generally be kept at or near the “0” position. Channels that are unused should have their gain controls kept fully counterclockwise at their (minimum) level. See the “Setting the Correct Gain Structure” section on page 23 in this manual for more information.

Guided Tour -

MIXPAD 4 Main Section

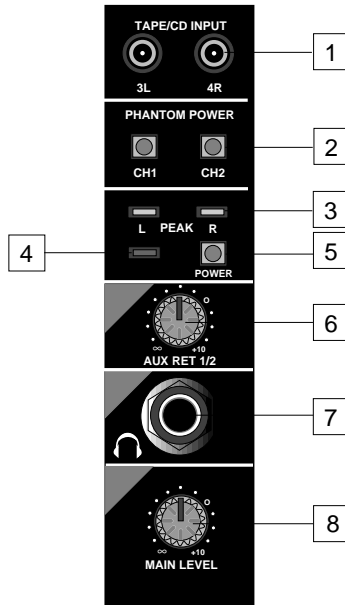

1: Tape/CD inputs (L, R) - Use this set of dual RCA jacks to connect the outputs of a tape or CD player to the MIXPAD 4. Signal connected here appears at the stereo channel (channels 3 and 4) and is mixed at unity gain with any line input signal connected to channel 3/4.

2: Phantom Power switches (Ch 1, Ch 2) - When pressed in, 18 volts of phantom power is delivered to pins 2 and 3 of the XLR mic connector of the selected channel. **WARNING:** Only use this switch with the MIXPAD 4 powered down. Before turning phantom power on, be sure to disconnect all non-microphone signal sources (such as passive direct injection boxes) from the XLR mic jacks. Although phantom power will have no adverse affect on connected dynamic microphones, it should be used only when one or more condenser microphones are connected to the MIXPAD 4. **Refer to the owners manual of your microphone or active direct injection (DI) box to determine whether or not it requires 18 volts of phantom power—Samson cannot assume responsibility if you damage a mic or DI box by incorrectly applying phantom power from the MIXPAD 4.** If you're not completely certain that one or more connected mics or active DI boxes require 18 volts phantom power, leave this switch off (its out position).

Guided Tour - MIXPAD 4 Main Section

3: Left/Right Peak LEDs (red) - These warning lights indicate an overload situation. They light whenever the main left or right output signal is 5 dB short of clipping. To stop them from lighting (and to eliminate the accompanying sonic distortion), turn down the Main Level control (see #8 below). See the “Setting the Correct Gain Structure” section on page 23 in this manual for more information.

4: Power LED (green) - This LED indicates battery strength. It flashes briefly whenever the MIXPAD 4 is powered on and lights steadily when the batteries are low and need replacing.

5: Power on-off switch - As you may have guessed, this is what you use to turn the MIXPAD 4 on and off. To avoid potential damage to your speakers, turn the unit on *before* you turn on any connected power amps—and turn it off *after* the power amps are turned off.

6: Stereo Auxiliary Return Level (tan) - This knob determines the input level of signal arriving via the MIXPAD 4’s stereo Auxiliary return. The Aux return is at unity gain (no boost or attenuation) when set to the “0” (2 o’clock) position; the signal is boosted when the knob is turned to the right of “0” and attenuated when turned to the left of “0.” For information on how to properly set this, see the sections in this manual entitled “Setting the Correct Gain Structure” and “Using Aux Sends and Returns” (pages 23 and 32). Note that signal applied to the Aux return is automatically routed to the Main L/R output.

7: Headphone jack - Connect any standard stereo headphones to this jack (via a standard 1/4" TRS plug) for private monitoring of the main stereo output (pre-Main Level). The built-in MIXPAD 4 headphone preamp delivers 38 mw at 600 ohms.

8: Main Level (white) - This knob determines the final output signal level—you can think of this as being the “master fader.” Signals from all channels and the Aux return, as well as the Tape/CD input are routed here just before leaving the MIXPAD 4 via its left and right main output jacks. The “0” position of the knob indicates unity gain (no level attenuation or boost). Moving the knob counterclockwise from the “0” position causes the signal to be attenuated (at the fully counterclockwise position, it is attenuated infinitely—in other words, there is no sound). Moving it clockwise from the “0” position causes the signal to be boosted by as much as 10 dB. Note that the Main Level control has no effect on the headphone level. For more information, see the “Setting The Correct Gain Structure” section on page 23 of this manual.

Guided Tour - MIXPAD 4 Jackfield

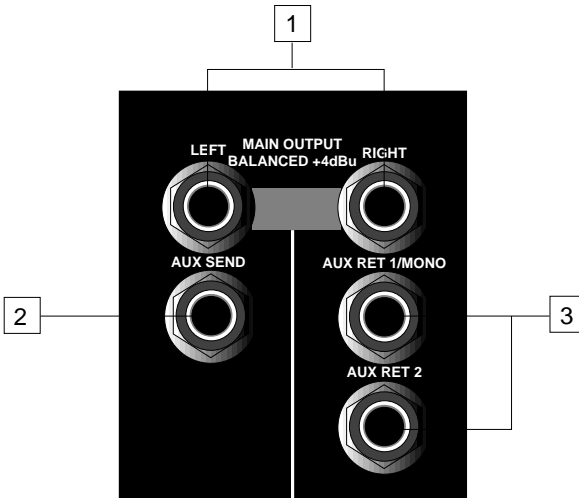

1: Main out (L, R) - These are the MIXPAD 4's main outputs. You'll usually use these to connect the MIXPAD 4 to a tape recorder or to a power amp and loudspeakers. The Main out jacks are electronically balanced, so you should use balanced three-conductor cabling and TRS plugs wherever possible (unbalanced two-conductor plugs can also be inserted into these outputs, but you'll get better signal quality and less outside noise and hum if you use balanced lines). See the "Connecting the MIXPAD" section on page 19 for more information.

2: Aux Send - This unbalanced 1/4" output allows you to route signal from any or all channels to external devices such as effects processors. The MIXPAD 4 Aux send is post-fade and post-EQ. See the "Using Aux Sends and Returns" section on page 32 for more information.

3: Aux Return (1/Mono / 2) - These unbalanced 1/4" inputs allow you to route signal from external devices such as effects processors to the MIXPAD 4's stereo Aux Return. When connecting only a single mono signal to the Aux Return, use the "Aux Ret. 1/Mono" input; the signal will then be automatically panned dead center. When connecting stereo signals, use both jacks; the signal connected to the "Aux Ret. 1/Mono" jack will be automatically panned hard left and the signal connected to the "Aux Ret 2" jack will be automatically panned hard right. See "Using Aux Sends and Returns" on page 32 for more information.

Connecting the MIXPAD - General Suggestions

The actual connections you'll make to and from the MIXPAD will vary according to the environment you use it in and the particular equipment you have, but here are a few basic rules concerning MIXPAD connections that will apply in most situations:

- In general, it's best to make all connections with the MIXPAD and any connected power amplifiers turned off. If you must make connections with the power on, make sure that the Main Level control is completely down (turn the knob fully counterclockwise). Whenever powering down, turn the Main Level control completely down and turn off the main power amps *first*. Wait a few seconds for their power supplies to discharge and then turn off all connected equipment, turning the MIXPAD off *last*.
- Try to use balanced connectors and cabling wherever possible. These kind of connections do a better job of rejecting extraneous noise and hum and generally provide a cleaner signal. Although the MIXPAD will accept unbalanced connectors throughout, it specifically provides electronically balanced inputs for all mono line inputs (channels 1 - 6 in the MIXPAD 12; channels 1 - 3 in the MIXPAD 9; and channels 1 - 2 in the MIXPAD 4) and for its main outputs. The wiring diagram below shows how 1/4" TRS (Tip/Ring/Sleeve) connectors should be wired for use with these inputs and outputs:



Unbalanced cables use standard 1/4" phone connectors, wired as follows:

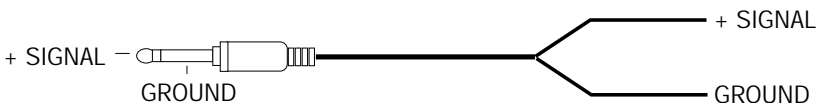

Connecting the MIXPAD - General Suggestions

- Make one connection at a time and then monitor the incoming signal. If you hear a distinct hum or buzz, you may have a grounding problem with that particular device. See the section in this manual entitled “Grounding Techniques” (on page 26) for more information.
- NEVER connect a microphone and line level input to the same channel simultaneously—use one or the other. You can have some channels connected to microphones and others to line level signals (for example, you might want to plug mics into channels 1 - 2 and line level signals into the remaining channels)—just don’t have both kinds of inputs connected to the *same* channel. The diagram below shows how your mic connectors should be wired:



- For easy control over a pair of matched signals (i.e. the left-right outputs of a stereo effects processor, keyboard, drum machine, tone generator, CD player, or tape recorder), use the MIXPAD’s stereo input channels. The Balance control in these channels will allow you to adjust the relative levels of the two inputs, and you can also equalize the stereo signal, with the same EQ settings applied to both inputs.
- There are additional “hidden” (or at least not so obvious) stereo inputs to the MIXPAD; these are the Aux returns. Use these whenever you want to bring in a stereo signal that will not need to be equalized. Bear in mind that the two stereo Aux returns in the MIXPAD 12 / MIXPAD 9 can also be used as four monophonic returns and that the single stereo Aux return in the MIXPAD 4 can also be used as two monophonic returns (when connecting only one monophonic signal, use the “Aux Ret. 1/Mono” jack so that the returning signal is automatically panned dead center).

Connecting the MIXPAD - General Suggestions

- In the MIXPAD 12 and MIXPAD 9, when connecting only one monophonic signal to a stereo channel, always use the upper input. When only the upper input is connected in a stereo channel, the MIXPAD 12/9 treats that channel as if it is a mono channel and the signal can then be panned (using the Balance control). See the “Using Pan/Balance” and “Using Aux Sends And Returns” sections in this manual (pages 28 and 32) for more information.
- In the MIXPAD 12 and MIXPAD 9, the Aux return jacks are unbalanced stereo inputs, with the tip carrying the left input signal and the ring carrying the right input signal (with the sleeve carrying common ground), as shown below (the MIXPAD 4 stereo channel line input is wired the same way). Insertion of a monophonic 1/4" jack into an Aux return will result in the incoming signal being automatically routed to the left input only (and therefore panned hard left).

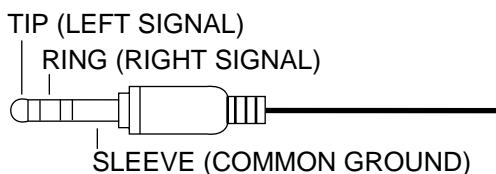

Setting Up and Using the MIXPAD

Setting up your MIXPAD is a simple procedure which takes only a few minutes:

1. Remove all packing materials (save them in case of need for future service) and decide where the unit is to be physically placed.
2. Begin by connecting the MIXPAD main left/right outputs to a tape recorder or power amp (and the amp into loudspeakers). It is never a good idea to power up any amplifier that is not connected to loudspeakers.
3. Next, make the signal input connections to the mic or line inputs of the various channels. **WARNING:** Because the MIXPAD 12 and MIXPAD 9 XLR mic connectors are always phantom powered (the MIXPAD 4 XLR mic connectors are powered only when the corresponding phantom power switch is pressed in), be sure to connect and disconnect microphones only with the MIXPAD powered off. Also, do not connect a channel's line input if you already have something connected to its microphone input, or vice versa; each channel is designed to accept only one source or the other.
4. Turn all channel Level and Trim controls as well as the Main Level control fully counterclockwise.
5. If you running the MIXPAD off mains power, plug the included power supply into the rear panel AC connector and then into any standard AC socket. If you are running a MIXPAD 12 or MIXPAD 9 off battery power, plug the battery connector into the rear panel AC connector (for more information on operating the MIXPAD 12 / MIXPAD 9 off battery power, see Appendix A on page 34); if you are running a MIXPAD 4 off battery power, place two or three fresh 9 volt alkaline batteries in the rear panel battery compartment (three are required only if you need to apply phantom power to one or both mic inputs), being careful to observe the indicated polarity.
6. Finally, press the Power switch in the main section to turn the MIXPAD on. In the MIXPAD 12 / MIXPAD 9, the "Power" LED will light steadily; in the MIXPAD 4, it will flash briefly to indicate good battery strength (the MIXPAD 4 "Power" LED lights steadily only when its batteries are weak and need replacing).

Setting the Correct Gain Structure

You're now ready to establish the correct gain structure—the key to getting the best performance from the MIXPAD, or from any mixer, for that matter. This is a simple procedure that ensures optimum input and output levels so that no unnecessary noise (caused by too low a signal) or overload distortion (caused by too high a signal) is created. Here's a step-by-step description of how to do so:

- a. With all connections made (as described above) but with the power amplifier and MIXPAD powered *off*, set the power amplifier volume to minimum. On the MIXPAD, turn all channel Trim and Level controls fully counterclockwise, and set the Main Level control to its “0” position.
- b. If you are using a MIXPAD 4 and either or both connected microphones require 18 volts phantom power, press in the corresponding phantom power switch.
- c. Set all channel equalizer and pan/balance knobs to their center detented “0” positions.
- d. Set all channel Aux send knobs and all Aux return level knobs fully counterclockwise.
- e. Turn on all devices connected to channel line inputs and Aux returns and set their level controls to unity gain or, if there is no unity gain indicated on their output control, to maximum. If you've got effects processors connected to Aux returns, make sure they are sending completely “wet” (processed) signal, with no “dry” (unprocessed) signal mixed in.
- f. Press the MIXPAD Power switch in order to turn the unit on. Finally, turn on the power amplifier and set it to a moderate listening level.
- g. Play an instrument connected to one of the MIXPAD's line inputs* and, while doing so, slowly raise the corresponding channel Level control to the 2 o'clock “0” position (for most line-level signals, the Trim control should remain fully counterclockwise). Listen for signs of any distortion. If you hear any, you may need to lower the output level of the instrument, though this will rarely occur. Conversely, if the signal is too low, something's wrong: in all likelihood, the connecting audio cable is faulty.

** If you're using an instrument such as electric guitar or bass, we recommend that you connect it to the MIXPAD with a direct injection box to ensure correct impedance.*

Setting the Correct Gain Structure

h. Once you've set the optimum level in step (g) above, continue playing the instrument and slowly raise the power amplifier volume until you reach the level you want to hear.

i. Repeat step (g) above for each instrument connected to the MIXPAD channel line inputs.

j. The procedure for setting optimum microphone levels is virtually identical; sing or speak into the mic at the level you expect to use in performance while slowly raising the Level control for that channel to its 2 o'clock "0" position. Then carefully raise the Trim control for that channel until the main Left/Right peak LEDs in the main section just begin to light occasionally during the loudest signals. Again, listen carefully for any signs of audible distortion or unusually weak signal (indicating a likely fault in cabling).

k. If you have any outboard signal processors connected to the Aux send and return jacks on the rear panel, follow this step. Because outboard effects processors can sometimes be quite noisy, it's particularly important to maximize the amount of signal being sent to them via the MIXPAD Aux sends. The idea is to drive these devices as hot as possible (short of overloading them) and then to use the corresponding Aux return level to carefully adjust the amount of processed signal being blended with the dry signal. To set optimum Aux send levels, use a channel that has already had its gain structure adjusted in step (g) or (j) above. Turn the Aux send knob(s) for that channel to the "0" (unity gain) position and then play the instrument (or sing into the microphone) connected to that channel. Adjust the input levels of connected outboard effects processors so that their meter shows incoming signal normally in the 0 vu range (with only occasional higher excursions). Then it's time to optimize the Aux return levels. While continuing to play your instrument (or continuing to sing into the microphone), slowly raise the Aux return level control(s) until you hear the desired amount of processed signal added to the dry signal. For more information, see the "Using the Aux Sends and Returns" section on page 32 in this manual.

Setting the Correct Gain Structure

I. The gain structure is now correctly set—you've optimized the level of all signals coming into and out of the MIXPAD, and the end result will be minimum noise and distortion and maximum clean sound. You'll now find that the majority of your mixes can be accomplished with most channel Level controls at or near their 2 o'clock "0" (unity gain) position and that the main Left/Right peak LEDs rarely if ever light (remember, if they do light, it means that something is distorting!). If you need to make adjustments to the overall level, alter the level control of your power amplifier.

If you encounter difficulty with any aspect of setting up or using your MIXPAD, you can call Samson Technical Support (1-800-372-6766) between 9 AM and 5 PM EST.

Grounding Techniques

Hum and buzz are the biggest enemies you face when interconnecting a large number of different pieces of equipment to a central audio mixer. This is because each piece of equipment may operate at a marginally different voltage (this difference is called *potential*) and, when two devices at slightly different potential are physically connected with audio cabling, the end result can be nasty, extraneous noise (mind you, connecting two devices at *very* different potential can result in a major electrical shock!).

However, there are several steps you can take to avoid grounding problems. First, assuming you have an isolated electrical circuit that can handle the electrical demands of your mixer and all connected audio equipment (these needs will usually be modest), you should always plug your mixer and all connected equipment into the same circuit. If possible, nothing else but this equipment should be connected to that circuit. If you can't do this, at least avoid plugging your mixer and audio equipment into the same circuit that is already powering things like heavy machinery, air conditioners, heaters, refrigerators, washing machines, neon signs or fluorescent light fixtures. One particular culprit that will almost certainly create problems is the standard light dimmer (the kind that uses silicon controlled rectifiers). Where low-level lighting is desired, use incandescent fixtures with autotransformer-type dimmers (sometimes called *Variacs*) instead—these cost considerably more than the standard dimmer you'll find at your local hardware store, but are well worth the extra expense.

If you hear hum or buzz from a device that uses an external two-prong AC/DC adapter (such as the MIXPAD), you can try reversing the plug in the socket. If that doesn't work, you may need to physically ground that device's chassis by connecting a wire (called a *strap*) from it to a grounded piece of metal. Some pieces of equipment have a screw-type ground post to which the strap can be connected; if not, you can attach some kind of metallic binding post to the case itself. If you are using rack-mounted audio devices and are experiencing hum or buzz, there's a simple test to determine the source of the problem: while keeping all devices powered on and connected with audio cabling, physically remove each device, one by one, from the rack. If the hum disappears when a particular device is removed, you'll know that device is probably the culprit.

Grounding Techniques

We also recommend that you use balanced audio cabling and connectors wherever possible. The MIXPAD provides electronically balanced inputs for mono line channel inputs and for its main outputs. The wiring diagram in the “Connecting The MIXPAD” section of this manual (on page 19) shows how 1/4" TRS (Tip/Ring/Sleeve) connectors should be wired for use with these inputs and outputs.

In addition, you can minimize possible interference by planning your audio, electrical, and computer cable runs so that they are as far apart from one another as possible and so they don't run parallel to one another. If they have to cross, try to ensure that they do so at a 90° angle (that is, perpendicular to one another). In particular, try to keep audio cabling away from external AC/DC adapters.

Another, less common problem you may encounter is that of *oscillation* (a ringing tone), which, apart from being annoying, is potentially dangerous to your speakers. This is generally caused either by poor outside wiring or by returning a signal out of phase (most commonly from an outboard signal processor). If audible oscillation occurs, try isolating each input signal by turning down all other inputs. If one signal alone is causing the problem, you should be able to eliminate the oscillation by reversing that signal's phase (many signal processors have a switch that allows you to do this).

Using Pan/Balance

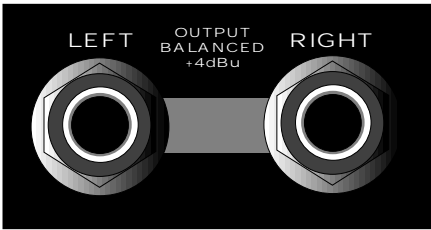

The final Main output of the MIXPAD is stereo—that is, there are two discrete output jacks, labeled “left” and “right,” which will normally be routed to a stereo power amplifier and two discrete speakers.* Because of this, you will usually be working



with a stereo field that ranges from hard left to hard right. The Pan control in monophonic channels (and the Balance control in MIXPAD 12 and MIXPAD 9 stereo channels, when only the upper input is connected) allows you to place each individual sound at any point within this left-right field, while keeping the overall level constant.



You can use stereo panning creatively in a variety of ways: For example, you might want to have guitars coming from one speaker and keyboards

from another, or you might use panning to “spread” the signal from a piano miked with two microphones—one over the bass notes (panned left) and the other over the treble notes (panned right). By turning a Pan knob while a signal is present, the sound appears to move in space (a process known as *dynamic panning*)—this can be particularly effective when applied to sound effects.

In live performance, you may want to resist the temptation to pan anything completely hard left or right, since some members of the audience not seated in the center of the venue may miss some signal altogether. In these circumstances, you’re best to use modest panning, with signals routed no further than the 9 o’clock and 3 o’clock positions.

* You can, of course, also use the MIXPAD monophonically—simply route the same signal to both the left and right outputs.

Using Pan/Balance

In the MIXPAD 4 stereo channel (channels 3/4) and in MIXPAD 12 and MIXPAD 9 stereo channels (channels 7/8, 9/10, and 11/12 in the MIXPAD 12; channels 4/5, 6/7, and 8/9 in the MIXPAD 9) where both inputs are connected, the upper input signal is automatically panned hard left and the lower input signal is automatically panned hard right. The Balance knob in these channels controls the *relative* levels of the two input signals. When the knob is placed at its center (detented) position, both the upper and lower inputs are at equal strength. When moved left of center, the signal of the upper channel remains the same but the signal of the lower channel is attenuated; when the knob is moved right of center, the reverse occurs: the signal of the lower channel remains the same but the signal of the upper channel is attenuated. When placed fully counter-clockwise, only the upper channel is heard; when placed fully clockwise, only the lower channel is heard.

Using Equalization

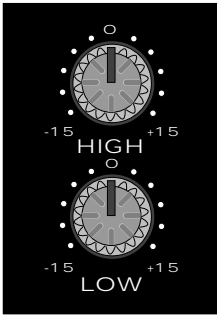

MIXPAD 12/9 EQ

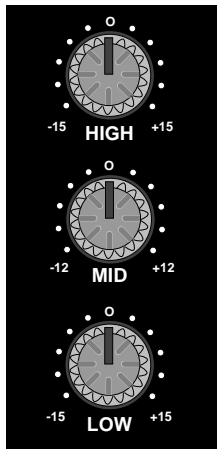

MIXPAD 4 EQ

One of the most exciting aspects of using a mixer such as the MIXPAD is the ability to shape a sound, using a process called *equalization*. But there are few areas of sound engineering more misunderstood than equalization, and, just as good EQ can really help a sound, bad EQ can really hurt it, so read on...

Every naturally occurring sound consists of a broad range of pitches, or *frequencies*, combined together in a unique way. This blend is what gives every sound its distinctive tonal color. The EQ section in a mixer allows you to alter a sound by boosting or attenuating specific frequency areas. The MIXPAD 12 and MIXPAD 9 both provide independent two-band equalization controls for each of their input channels, while the MIXPAD 4 provides independent three-band equalization controls for each input channel. In all models, the EQ controls in stereo channels affect both input signals identically.

Each EQ knob is labeled with the maximum amount of cut or boost provided (± 15 dB in the case of the High and Low frequencies, and, in the MIXPAD 4, ± 12 dB in the case of the Mid frequency). In the MIXPAD 12 and MIXPAD 9, the

High EQ knob affects frequencies above 10 kHz, while the Low EQ knob affects frequencies below 100 Hz (with both using a *shelving* curve). In the MIXPAD 4, the High EQ knob affects frequencies above 12 kHz, while the Low EQ knob affects frequencies below 80 Hz (with both again using a *shelving* curve). The MIXPAD 4 also provides an additional Mid EQ knob, affecting frequencies around 2.5 kHz (using a *bell*, or *peaking* curve). We provided these particular frequency areas because they have maximum impact on musical signals—that's why they are sometimes known as "sweet spots." When an EQ knob is in its center detented position (at "0"), it is having no effect. When it is moved right of center, the particular frequency area is being boosted; when it is moved left of center, the frequency area is being attenuated.

Using Equalization

In most instances, the best way to approach equalization is to think in terms of which frequency areas you need to attenuate, as opposed to which ones you need to boost (boosting a frequency area also has the effect of boosting the overall signal; too much EQ boost can actually cause overload—with the accompanying Left/Right Peak LED warning!). Be aware of the phenomenon of *masking*, where loud sounds in one frequency range obscure softer sounds in the same range; by cutting EQ “notches” in a loud signal, you can actually make room for a softer one to shine through. And try not to think of EQ as a miracle worker—no amount of equalization can put a singer in tune or remove the distortion from an overloaded input signal! The key is to get the signal right in the first place, by using correct gain structure and mic placement.

Although the specific EQ you will apply to a signal is very much a matter of personal taste, here are a few general suggestions: Boosting the low frequency of instruments such as bass drums or bass guitar will add warmth and make the sound “fatter”; conversely, you may want to attenuate the low frequency component of instruments such as cymbals, high-hats, and shakers so as to “thin” them out. Be careful not to boost high frequencies too much or you risk adding hiss to the signal, though just a touch can help add “shimmer” to an acoustic guitar, ride cymbal, or high-hat. If you are using a MIXPAD 4, you’ll find the mid-range EQ control to be particularly effective for vocals—attenuating it can give a vocal performance more of an “FM-radio” feel and boosting it can help a vocal cut through dense instrumentation. Finally, because the MIXPAD’s High and Low EQ controls both utilize shelving curves, attenuated High EQ settings can be used to reduce hiss (which is composed almost exclusively of high frequencies) and attenuated Low EQ settings can be used to reduce rumble (which is composed almost exclusively of low frequencies).

Using Aux Sends and Returns

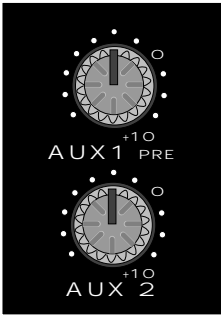

MIXPAD 12/9 Aux sends

The purpose of Auxiliary sends are to allow you to combine the signal from multiple channels and send the resulting mix to external devices such as effects processors. The MIXPAD 12 and MIXPAD 9 provide two such sends, while the MIXPAD 4 provides one.

When a channel's Aux send knob is at its "0" position, the signal is routed with unity gain (that is, no boost or attenuation). As it is turned clockwise from the 0 position, the signal is boosted; as it is turned counterclockwise from the 0 position, it is attenuated. In the MIXPAD 12 and MIXPAD 9, Aux send 1 is post-eq but *pre-fader*, that is, the level of the signal sent through this knob is determined by the EQ settings and (in mono channels) the position of the Trim control. It is, however, unaffected by the channel Level setting; for this reason, it is optimum for applications like headphone cueing or sending a feed to onstage monitors—both situations where you want the performer's mix to be independent of the main mix. You can also use Aux 1 to route signal to a reverb processor in order to create a distancing kind of effect where the "wet" reverb signal remains constant even as the "dry" source signal fades away. In contrast, Aux send 2 is post-eq and *post-fader*, that is, the level of the signal is determined by EQ settings and the channel Level setting, as well as (in mono channels) the position of the Trim control. This is the condition of the single Aux send provided by the MIXPAD 4. Here, raising or lowering the Level of the channel will affect the send level as well.

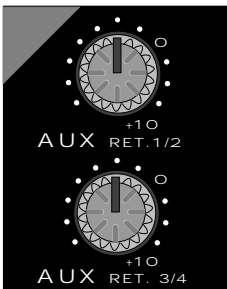

MIXPAD 12/9 Aux returns

The MIXPAD 12 and MIXPAD 9 also provide two stereo Aux returns (the MIXPAD 4 provides one stereo Aux return). These allow you to return signal from outboard devices, either in stereo pairs or monophonically (many popular effects processors provide a single mono input but have two stereo outputs). You can think of the MIXPAD's stereo Auxiliary returns as being somewhat similar to a stereo channel, except that a signal being brought into to a stereo channel can be equalized if necessary and optionally sent on to other

Using Aux Sends and Returns

outboard devices (via Aux sends). In practice, you'll probably want to use the Aux returns to bring in signal from connected effects processors. If the effects processors have stereo outputs, they should be connected to both the left and right Auxiliary return inputs so that their stereo integrity is retained. If they have mono outputs, you can route them to either the left or right inputs. In this way, you can actually connect up to four monophonic devices to the MIXPAD 12 or MIXPAD 9's Aux return section (or two monophonic devices to the MIXPAD 4's Aux return). Signal arriving at the left input is automatically panned hard left and signal arriving at the right input is automatically panned hard right.

In the MIXPAD 12 and MIXPAD 9, the Aux return jacks are unbalanced stereo inputs, with the tip carrying the left input signal and the ring carrying the right input signal (the sleeve carries common ground), as shown in the wiring diagram on page 21 of this manual. Insertion of a monophonic 1/4" jack into an Aux return will result in the

incoming signal being automatically routed to the left input only (and therefore panned hard left). The MIXPAD 4 provides independent unbalanced 1/4" inputs for each Aux return "side." When connecting only a single mono signal to the MIXPAD 4 Aux Return, use the "Aux Ret. 1/Mono" input; the signal will then be automatically panned dead center. When connecting stereo signals, use both jacks; the signal connected to the "Aux Ret. 1/Mono" jack will be automatically panned hard left and the signal connected to the "Aux Ret 2" jack will be automatically panned hard right.

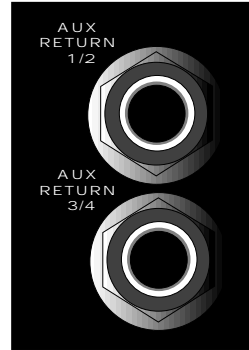

MIXPAD 12/9 Aux return jacks

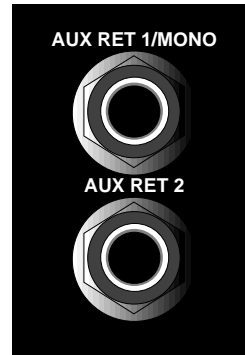

MIXPAD 4 Aux return jacks

Appendix A: Operating the MIXPAD 12/9 off Battery Power

The MIXPAD 12 and MIXPAD 9 can optionally be battery powered. This requires the use of two 12 Volt rechargeable Lead-Acid (Gelcell) batteries, connected to the rear panel AC connector, wired as shown in the illustration below. These batteries will provide the necessary bi-polar voltages needed to operate and maintain excellent audio quality.

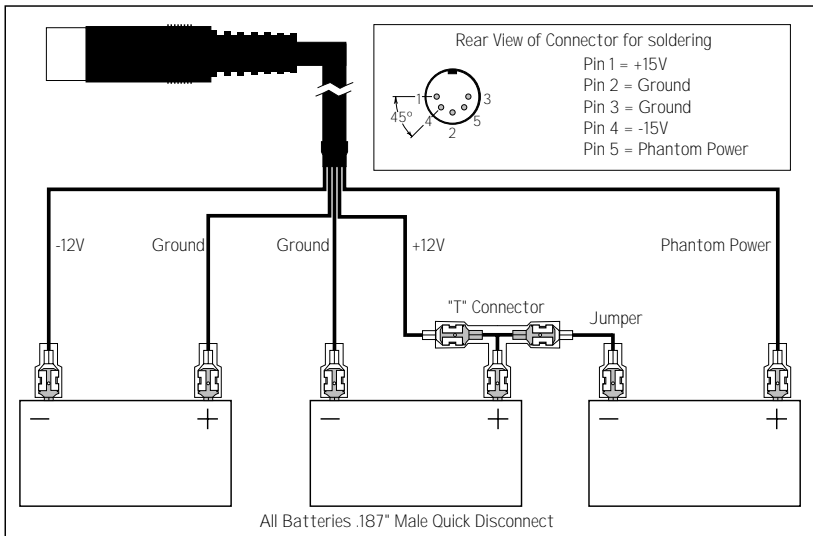
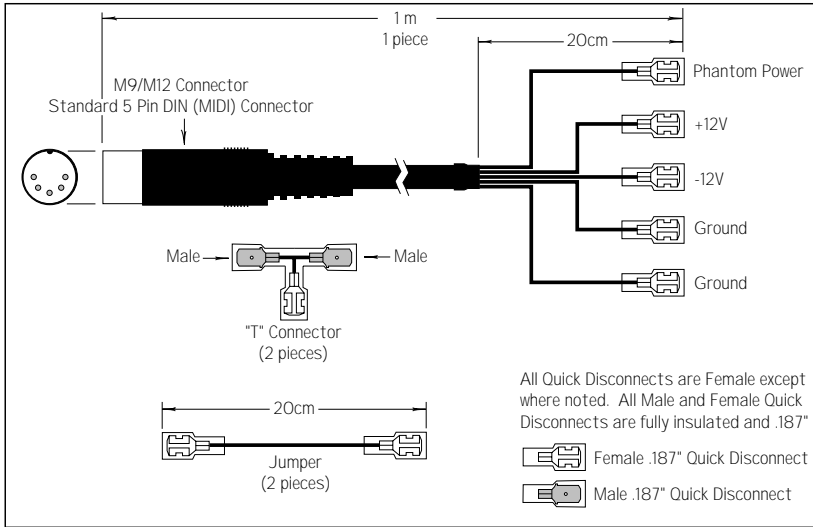

Appendix A: Operating the MIXPAD 12/9 off Battery Power

The current draw of the two models (without phantom power) are:

MIXPAD9:	125mA (.125A)
MIXPAD12:	160mA (.160A)

Typical usage times for the two models:

MIXPAD9	10 hours
MIXPAD12	8 hours

If you are using dynamic microphones, no phantom power is necessary. To power a condenser microphone, we recommend the use of one additional 12 Volt rechargeable battery. (Note: Batteries come with many connector options. We recommend the type with .187" quick disconnects for ease of connection.) Optional battery connect kits for both the MIXPAD9 and MIXPAD12 are also available; contact your local authorized Samson Audio dealer for more information.

Recommended batteries:

PowerSonic	PS-1212
Eagle Picher	CF12V1.5
Panasonic	LCR12V1.3P
Yuasa	NP1.2-12
Union	MX12012

Batteries and rechargers are available through the following national electronic parts distributors:

For PowerSonic and Eagle-Picher Batteries and accessories:

MOUSER Electronics (800-346-6873)
RS Electronics (800-555-5312) (PowerSonic only)

For Panasonic batteries and accessories:

Digi-Key (800-344-4539)

For Yuasa batteries and accessories:

Newark Electronics (800-367-3573)

For Union batteries and accessories:

Plainview Batteries (516-249-2873)

If you require any assistance regarding use and/or purchase of batteries, please feel free to contact the Samson Technologies Customer Service Dept. at 516-364-2244 between 9AM and 5PM EST.

MIXPAD 12 / 9 Specifications

	Normal	Limit
Frequency Response (Trim @ Min, unity gain \pm 3 dB)		
Mic to Main	5 Hz - 65 kHz	10 Hz - 50 kHz
Line to Main	5 Hz - 65 kHz	
Aux Return to Main	5 Hz - 75 kHz	
Line to Aux Send 1/2	5 Hz - 75 kHz	
T.H.D. (Trim @ Min, +4dBu output, unity gain, 1 kHz w/30 Hz LPF)		
Mic/Line to Main (Mono Ch)	0.002%	0.01%
Line to Main (Stereo Ch)	0.002%	0.01%
Line to Aux Send	0.002%	0.01%
Equivalent Input Noise ("A" filter on, input shorted)		
Mic	-128 dB	-128 dB
Line	-111 dB	-111 dB
Maximum Voltage Gain		
Mic to Main	74 dB	
Line to Main (Mono Ch)	54 dB	
Line/Tape to Main (Stereo Ch)	34 dB	
Aux Return to Main	20 dB	
Mic to Aux Send 1 (Mono Ch)	64 dB	
Mic to Aux Send 2 (Mono Ch)	74 dB	
Line to Aux Send 1 (Stereo Ch)	24 dB	
Line to Aux Send 2 (Stereo Ch)	34 dB	
Residual Noise (30 kHz LPF, all control Min)		
L/R Main	100 dB	95 dB
Aux Send 1/2	92 dB/91 dB	85 dB
Crosstalk (@ 1 kHz w/ 30 kHz LPF)		
Ch vs. Ch	77 dB	70 dB
Input vs. Output	82 dB	75 dB
Peak LED Sensitivity (before clipping)	3 dB	3 \pm 2dB
Headphone output (600 ohm load)	112 mW	100 mW
Maximum Input Level (1 kHz, \pm 3dB)		
Mic Input (Mono Ch)	+22 dBu	
Line Input (Stereo Ch)	+7 dBu	
Input Channel Equalizer (\pm 2dB)		
High (shelving)	10 kHz \pm 15 dB	
Low (shelving)	100 Hz \pm 15 dB	
Dimensions (W x D x H)		
	MIXPAD 9: 239 x 228 x 58 mm	
	(9.4 x 9 x 2.3 in.)	
	MIXPAD 12: 324 x 228 x 58 mm	
	(12.75 x 9 x 2.3 in.)	

MIXPAD 4 Specifications

	Normal	Limit
Frequency Response (Trim @ Min, unity gain \pm 3 dB)		
Mic to Main	5 Hz - 54 kHz	10 Hz - 50 kHz
Line to Main	5 Hz - 54 kHz	
Aux Return to Main	5 Hz - 98 kHz	
Line to Aux Send	5 Hz - 57 kHz	
T.H.D. (Trim @ Min, +4dBu output, unity gain, 1 kHz w/30 Hz LPF)		
Mic/Line to Main (Mono Ch)	0.02%	0.05%
Line to Main (Stereo Ch)	0.02%	0.05%
Line to Aux Send	0.02%	0.05%
Equivalent Input Noise ("A" filter on, input shorted)		
Mic	-128 dB	-128 dB
Line	-104 dB	
Maximum Voltage Gain		
Mic to Main	74 dB	
Line to Main (Mono Ch)	56 dB	
Line/Tape to Main (Stereo Ch)	34 dB	
Aux Return to Main	20 dB	
Mic to Aux Send	74 dB	
Line to Aux Send (Stereo Ch)	34 dB	
Residual Noise (30 kHz LPF, all control Min)		
Main	-89 dBu	-85 dBu
Aux Send	-86 dBu	-82 dBu
Crosstalk (@ 1 kHz w/ 30 kHz LPF)		
Ch vs. Ch	75 dB	70 dB
Input vs. Output	87.5 dB	80 dB
Peak LED Sensitivity (before clipping)	5 dB	5 \pm 2dB
Headphone output (600 ohm load)	38 mW	30 mW
Maximum Input Level (1 kHz, \pm 3dB)		
Mic Input (Mono Ch)	10.5 dBu	
Line Input (Stereo Ch)	7.6 dBu	
Input Channel Equalizer (\pm 2dB)		
High (shelving)	12 kHz \pm 15 dB	
Mid (peaking)	2.5 kHz \pm 12 dB	
Low (shelving)	80 Hz \pm 15 dB	
Dimensions (W x D x H)	163 x 228 x 69 mm (6.4 x 9 x 2.7 in.)	
Weight	900 g. • 2 lbs.	

Notes